



## LUMINARIA PARA DESCOLGAR | DYROY LCL253 - 60W

### Especificaciones Técnicas

Ítem No.	LCL25360AW	LCL25360AN	LCL25360AD
Color	Negra	Negra	Dorada
Consumo	60W	60W	60W
Tensión	100-277V	100-277V	100-277V
Flujo Luminoso (Lm)	60-70Lm/W	60-70Lm/W	60-70Lm/W
Temperatura de Color (K)	3000K	3000K	3000K
Índice de Reproducción Cromática (IRC)	≥80	≥80	≥80
Factor de Potencia	≥ 0.9	≥ 0.9	≥ 0.9
Temperatura de funcionamiento	-20°C~+40°C	-20°C~+40°C	-20°C~+40°C

## Características

<b>Atenuable (Dimerizable)</b>	No dimerizable
<b>Aplicación</b>	Descolgar
<b>Material</b>	Aluminio + Metal + Acrílico
<b>Angulo de apertura</b>	120°
<b>Vida útil</b>	50000Hrs
<b>Tipo de LED</b>	SMD

## Precauciones al instalar

- La instalación debe realizarse estrictamente de acuerdo con las instrucciones.
- Abstenerse de instalar la luminaria en zonas inestables, deformadas o dañadas.
- Asegúrese de haber cortado la fuente de alimentación antes de instalar, cambiar o limpiar la lámpara.
- Asegúrese de que no haya ningún componente suelto.

## Diagrama de medidas

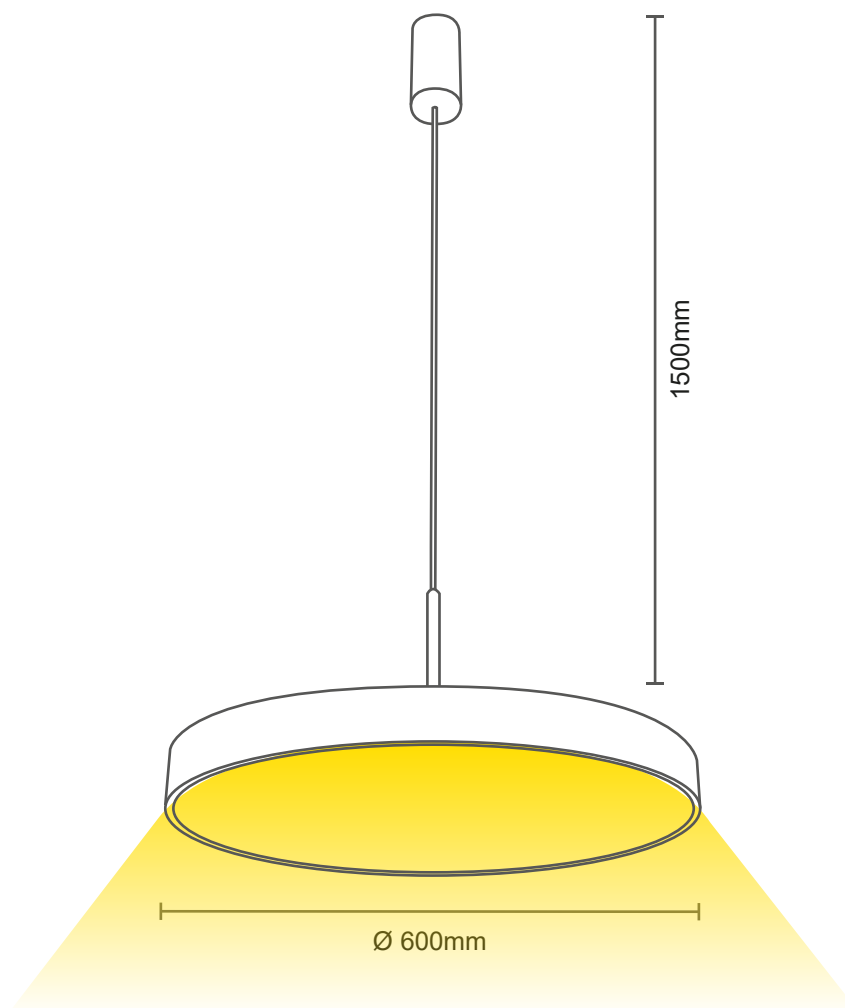

## Instalación:

